

Dimensions in centimetres.

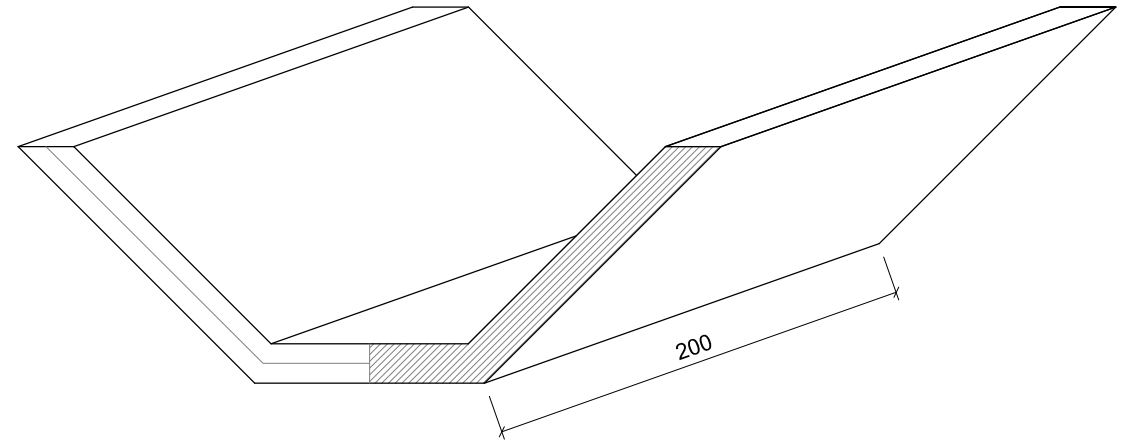
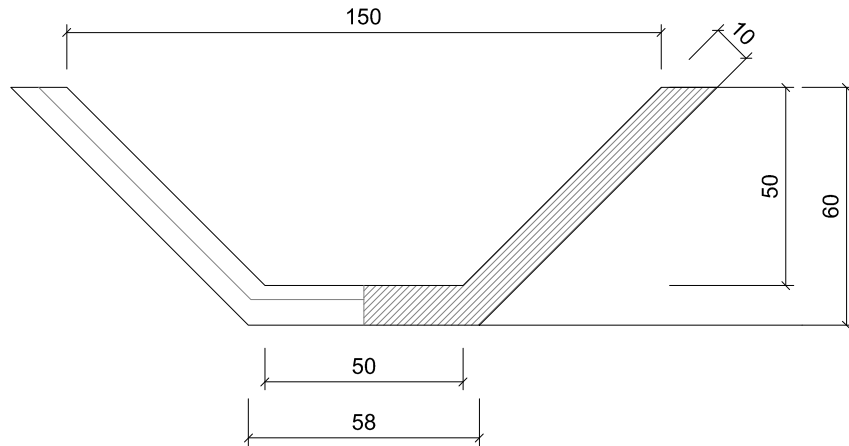

TECHNICAL DATA SHEET

CONCRETE STRENGTH :	C 25/30
CEMENT :	CEM 42.5 R
STEEL:	B450C
W/C RATIO:	0.50
PRODUCTION TECHNOLOGY :	VIBRATION
WEIGHT :	550 Kg/m